

D2 Turbo Pocket mechanical
installation guide



CENTURION



**DOMESTIC
SLIDING GATE
OPERATOR**

1. Introduction >>

This guide is designed specifically for installers who are familiar with the installation of standard sliding gate motors, but do not know the specifics of the **D2 Turbo**.

2. Important safety instructions >>



Please do not proceed with the installation until you have read and fully understand the Safety instructions included in your product packaging. The Safety instructions are also available on www.centsys.co.za, and may also be obtained by contacting Centurion Systems on +27 860 236 887 (SA only).

3. Icons used in this guide >>



This icon indicates tips and other information that could be useful during the installation.



This icon denotes variations and other aspects that should be considered during installation.



This icon indicates a warning, caution or attention! Please take special note of critical aspects that MUST be adhered to in order to prevent injury.

4. General description >>

The **D2 Turbo** domestic sliding gate operator has been designed solely to open and close domestic sliding gates. It must not be installed or used to automate the entrances of townhouse complexes, housing estates, industrial sites, etc.

5. Technical specifications >>

It is a 12V DC battery operated unit with the following limitations:

Gate mass maximum:	250kg
Starting pull force:	< 18kgf
Rated running force:	< 9kgf
Maximum speed:	24 metres/minute
Maximum gate length:	10 metres
Design life:	Ten years at ten cycles per day

6. D2 Turbo identification >>

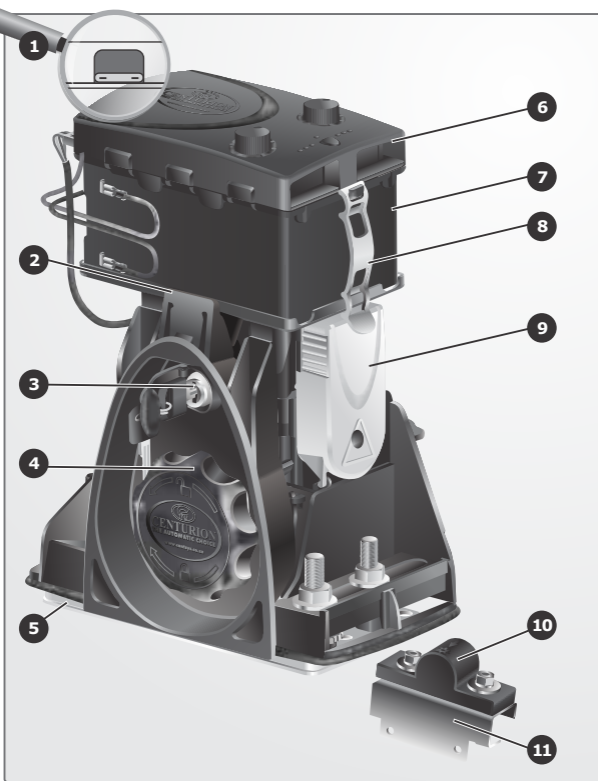

Which bit is what?

- | | |
|-------------------------------|--------------------------------|
| 1. Motor fuse | 7. 12V 7.2Ah or 5Ah battery |
| 2. Motor enclosure unit | 8. Battery strap |
| 3. Camlock cover | 9. Pulley guard |
| 4. Release thumbwheel | 10. Gate mounted origin marker |
| 5. Foundation plate | 11. Origin marker bracket |
| 6. D2 Turbo controller | |

7. Cabling requirements >>

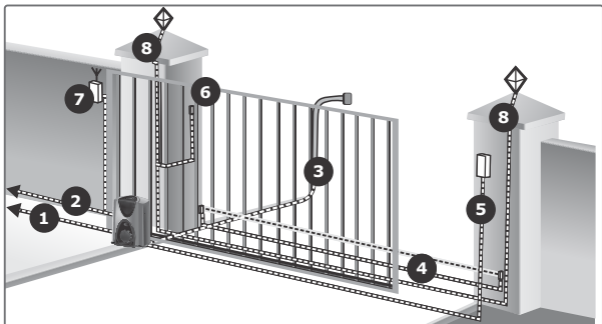

Legend

- 10V - 24V AC or 10V - 28V DC supply cable via step-down transformer (mounted in house/dwelling) (2 core cabtyre or twinflex, thickness depending on distance of cable run and transformer output voltage. Refer to Cable Thickness Table in the User Guide)*

Optional wiring (all cable is multi-stranded):

- Intercom cable from motor to dwelling (n1 + 6 core 0.5mm²)✦
- Intercom cable from motor to entry panel (n2 0.5mm²)
- Safe CLS:** Recommended infrared safety beams (3 core 0.5mm²)
- TRG:** Access control device (3 core 0.5mm²)
- PED:** Optional pedestrian keyswitch (a) or keypad (b) (3 core 0.5mm²)
- TRG:** Optional external radio receiver (3 core 0.5mm²)✧
- LIGHT:** Optional pillar lights (3 core LNE SWA, size according to power requirements)

n1 = number of cores required by intercom

n2 = number of cores required by intercom

* Possibly increase cable thickness if pillar lights are installed

✦ Allows for all features such as pedestrian opening, status LED, etc., to be operated from the intercom handset inside the dwelling. Number of cores and type of cable could vary depending on brand of access control system being used

✧ For optimum range, an external receiver can be mounted on the wall



Ensure that all the standard considerations for a quality gate installation are adhered to as specified in Centurion Systems' comprehensive installation manuals. If you are unfamiliar with these, then you may find them on www.CentSys.com. However, as a minimum please ensure that:

- There is unobstructed access in and out of the premises
- The operator must not protrude into the driveway
- Endstops are mandatory and must be capable of stopping the gate at rated speed
- Guide-rollers and anti-lift brackets are correctly fitted
- The specified gate mass, starting- and rated-pull-force limitations are not exceeded
- All relevant safety instructions are adhered to

Mount the operator

8A. Selecting Manual Mode

- 8A.1. Insert the camlock key and rotate it 90° **clockwise**. This will allow for the removal of the cover, as well as for the rotation of the Manual Release thumbwheel.

- 8A.2. The motor pinion can be put into 'Manual Mode' (unlocked) by rotating the Manual Release thumbwheel **counter-clockwise** through approximately 90°.

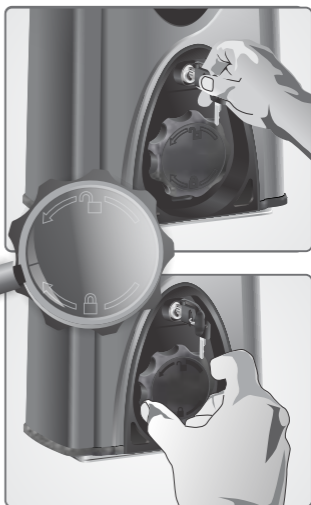

Using the camlock, it is possible to lock the operator cover in place with the Manual Release thumbwheel in either the 'locked' or 'unlocked' position



When locked, the Manual Release thumbwheel cannot be moved from 'locked' to 'unlocked' or vice versa

8B. Locate entry points for conduits/cables

- 8B.1. Cable entry is allowed for on the far left hand side corner of the gearbox.

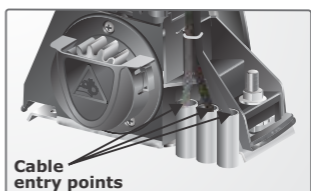

8B.2. Fit the mounting studs to the foundation plate and secure in place with the stud locknuts.

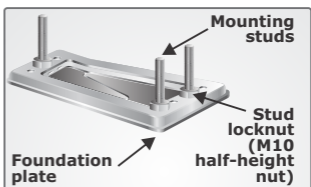

8B.3. Position the foundation plate to allow for the pinion to be unmeshed from the rack when the gearbox has to be removed.

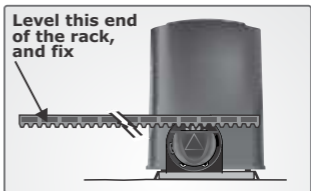

Leave clearance under the gearbox to allow for the gearbox to be lowered if the rack and pinion mesh is too tight.

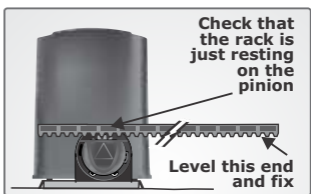

 A gap of 3mm between the rack and the pinion must be maintained.

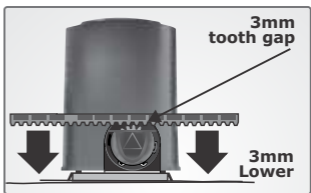

8B.4. Fit RAZ/Nylon/Steel angle rack as recommended by Centurion Systems. Use height-adjustment nuts to obtain correct rack and pinion mesh. Rack can be mounted above or below the pinion to suit site conditions. Refer to illustration A1, A2, A3, B1, B2 and B2.

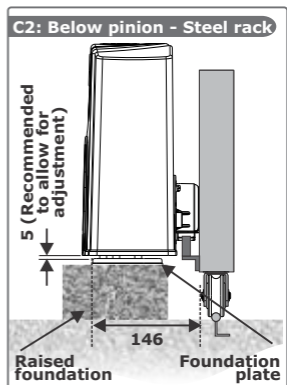
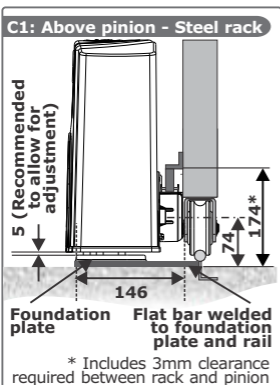
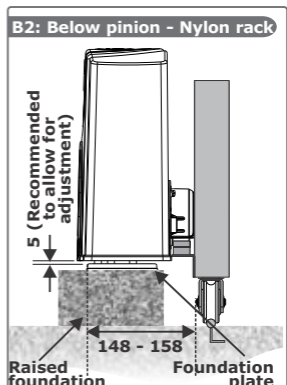
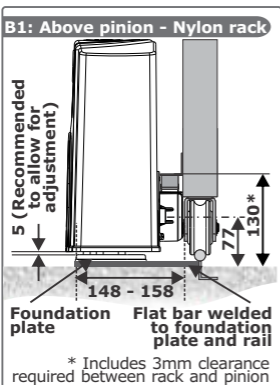
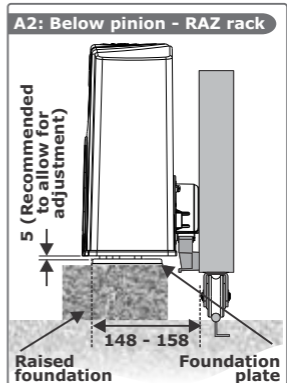
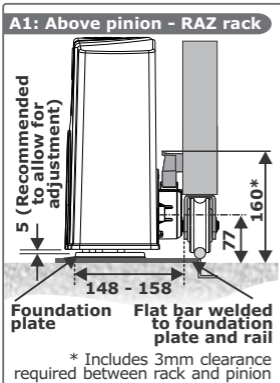



The pinion guard is easily removed and rotated allowing the rack to be fitted above or below the pinion.



8B.5. Use the orange height-adjustment nuts provided to level the gearbox.

8B.6. Tighten the hold-down nuts when the gearbox is in the correct position.

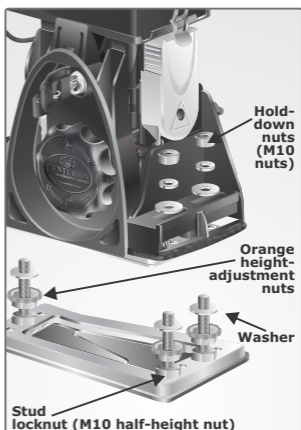

Theft-resistant nut and Discus padlock are available from CENTURION for sites requiring additional security.

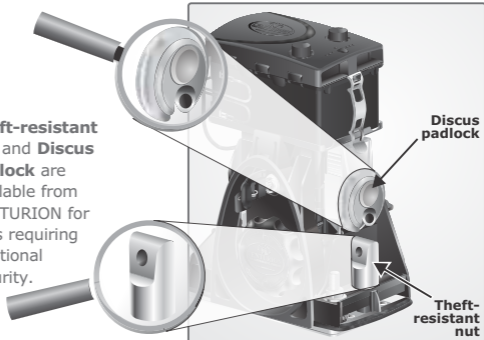

8B.7. Mount gate origin marker to rack as per illustration C, D and E, with the gate in the closed position.

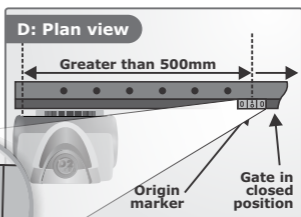
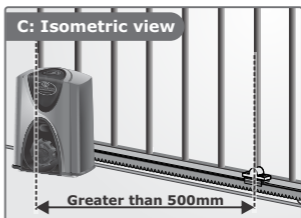

Take care with the orientation of the arrow on the origin marker. This arrow must face the operator.

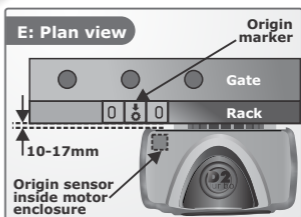

8B.8. Battery is fitted between the **motor enclosure unit** and the **D2 Turbo controller**.

8B.9. Unclip the orange clips holding the controller onto the motor enclosure unit.

8B.10. Fit the 7.2Ah/5Ah battery and clip the orange clips down to secure the battery in place.

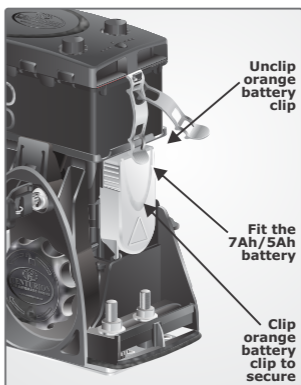

9. Electrical setup >>



9.1. Always check that the circuit breaker in the electrical panel is in the OFF position, and that all high voltage circuits (more than 42.4V) are completely isolated from the mains supply before doing any work.

9.2. Ensure that all low voltage systems (less than 42.4V) are suitably protected from damage, by disconnecting all sources of power such as chargers and batteries before doing any work.

9.3. All electrical work must be carried out according to the requirements of all applicable local electrical codes. (It is recommended that a licensed electrical contractor perform such work.)

Connect all wiring

Wire the controller to the required input and output devices as per the wiring diagrams on the right hand side.

10. Setting up the system >>

Refer to the illustration of the **D2 Turbo** controller, which shows the position of the **Function** and **Setting Dials**, the **status LED**, and the **select/toggle Pushbutton**.

All programming is done by means of two rotary Dials, a Pushbutton, and the bi-colour (red and green) status LED.

The rotary **Function Dial** selects the required function you wish to set. **This is selected first.**

Secondly, the rotary **Setting Dial** dials in the actual setting for the function selected.

10A. Using the Pushbutton and status LEDs

- To select a particular setting, press the **pushbutton**
- The **status LED** indicates the **status of the setting**
 - A **green status LED** indicates that particular setting is **selected**
 - A **red status LED** indicates it is **off or not selected**

If the setting is a single fixed value, e.g. 15 second autoclose time, then the pushbutton acts as a **select**.

If the setting has an option such as **On/Off**, or **Hi/Low** then the **pushbutton** will act as a **toggle**.

- If the **status LED is green**, then the **first option is selected**
- If the **status LED is red**, then the **second option is selected**

10B. Using the Function Dial

The **Function Dial** has six different settings that may be selected:

- RUN:** Fully anti-clockwise. The unit **must** be left in this position for "Normal run" operation
- A - LIMITS:** Sets up the gate open and closed positions automatically.
- B - REMOTES:** Allows for NOVA remotes to be added or deleted
- C - AUTOCLOSE:** Allows for different Autoclose times to be set
- D - MODE:** Allows for different modes of operation to be set
- E - PROFILE:** Allows for specific gate profiles to be toggled **On/Off** or **Hi/Low**

10C. Using the Setting Dial

The **Setting Dial** has six different positions, which allow the function required, to be selected.

Function dial	Setting dial (Ring position-Dial position)
A - LIMITS	A-1 Automatic; Start with gate closed
B - REMOTES	B-1 Learn a transmitter button to Trg
	B-2 Learn a transmitter button to Ped
	B-3 Learn a transmitter button to Lck
	B-4 Delete a transmitter
	B-5 Delete all transmitters
C - AUTOCLOSE	C-1 Autoclose off
	C-2 Autoclose after 5 seconds
	C-3 Autoclose after 10 seconds
	C-4 Autoclose after 15 seconds
	C-5 Autoclose after 30 seconds
	C-6 Autoclose after 45 seconds
D - MODE	D-1 Standard Mode
	D-2 Open Only Mode
	D-3 Reversing Mode
	D-4 PIRAC Mode On Off
	D-5 Pre-Flash Mode A* On Off
	D-6 Pre-Flash Mode B* On Off
E - PROFILE	E-1 Positive Close Mode
	E-2 Speed Hi Low*
	E-3 Sensitivity Hi Low
	E-4 Backup to Backup Memory Module*
	E-5 Restore from Backup Memory Module*

Use toggle pushbutton to select preference.

For D - MODE, **green** status LED=On; **red** status LED=Off

For E - PROFILE, **green** status LED=High; **red** status LED=Low

* PFA: The Pillar Light relay will activate for two seconds before gate movement occurs, as well as during gate movement.

This means gate movement will be delayed for a period of two seconds after a trigger has been received

* PFB: The Pillar Light relay will only activate during gate movement

⚙ High Speed: Gate will operate at its maximum speed – typically 24 metres per minute

* Low Speed: Gate will operate at 16 metres per minute

⚙ • If **Backup to Backup Memory Module** or **Restore from Backup Memory Module** are required, remove ENCODER/ORIGIN connector and fit CP108 (Backup Memory Module)

• Any controllers not marked with 'BACKUP' and 'RESTORE' do not support this function

• **E-4 and E-5 text is not screened on the BETA versions**

110 - 220V Mains in

Waterproof isolator enclosure within two metres of motor

Pillar Light/ Courtesy Light optional

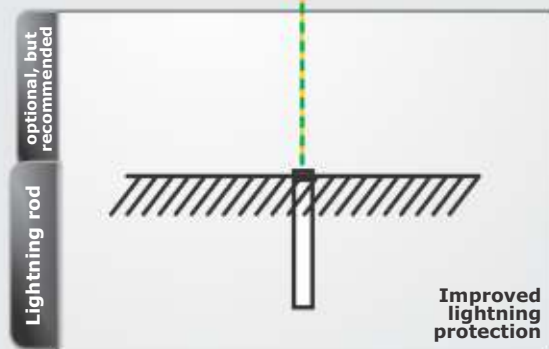
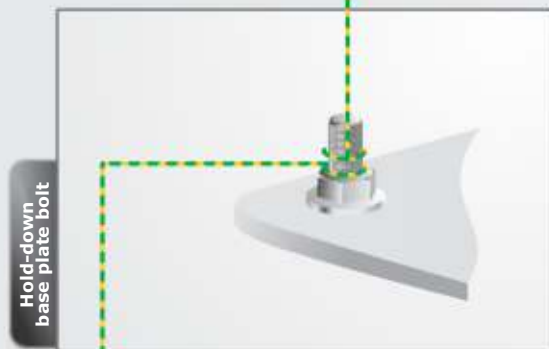

★ Optional
✦ Recommended

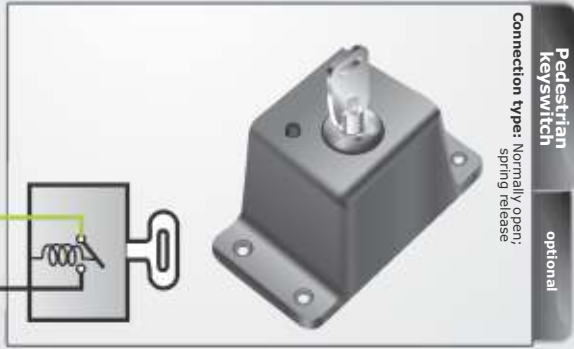
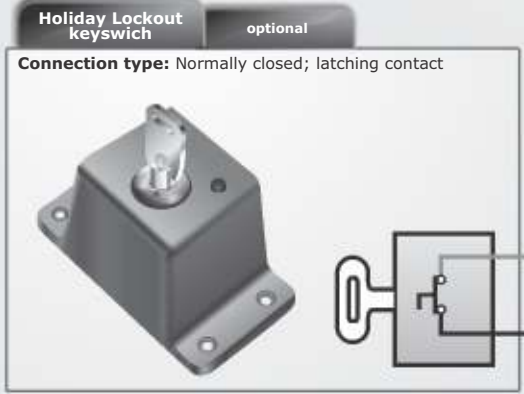
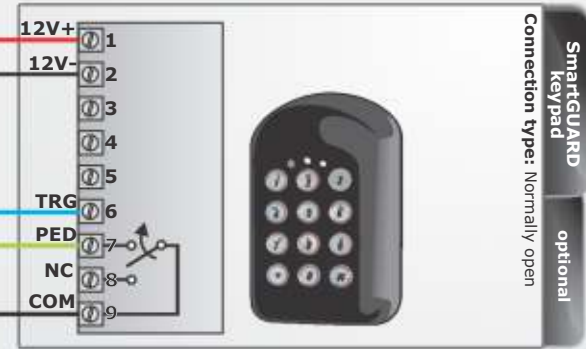
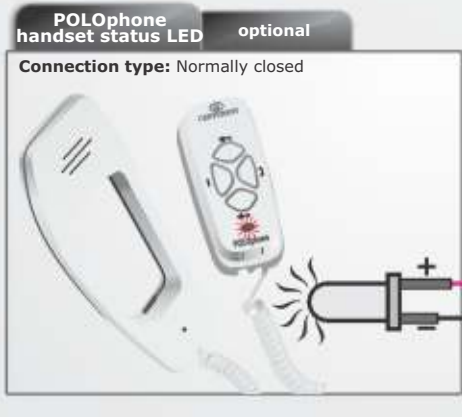
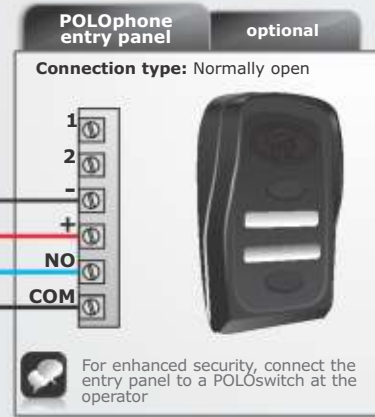
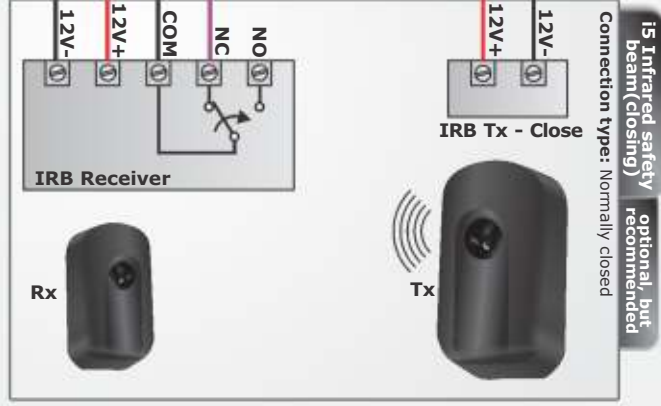
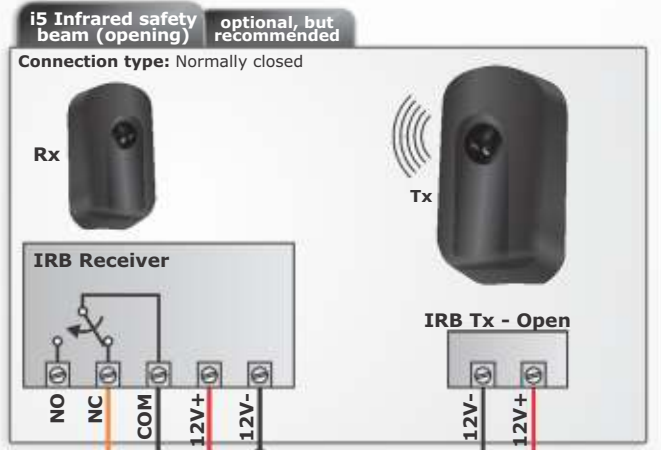
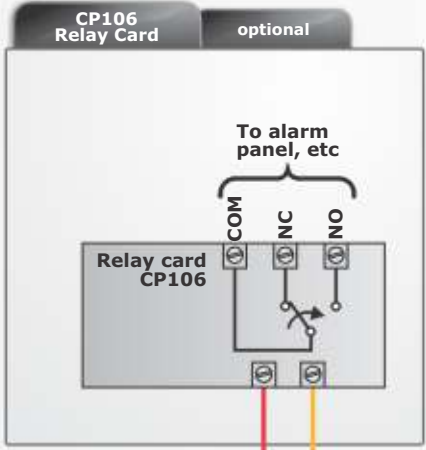



Sharecall 0860-CENTURION (0860 236 887)
Head Office: +27 11 699 2400

Sharecall Technical Support 0861 003 123 or
+27 11 699 2481
from 07h00 to 18h00 (GMT+2)

(Sharecall numbers applicable when dialed from within South Africa only)



0.07.A.0095_05022014

www.centsys.com